

CATALOG
2025-2026 NA MARKET

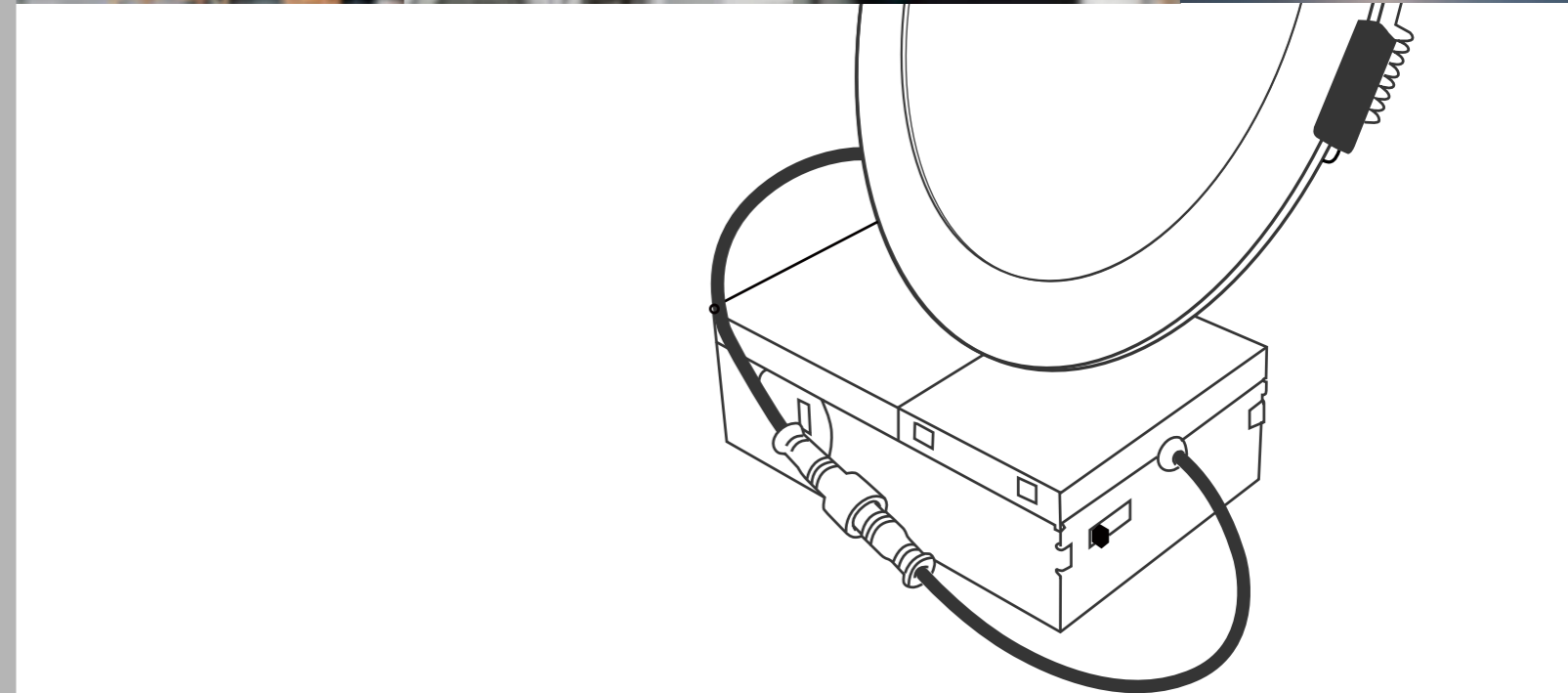

JIANGXI JINGKE ELECTRONICS CO., LTD

Address: Meidi Road, Guixi Industrial Zone, Guixi City,
Jiangxi Province, China.

Zip code:335400

Foshan Office: Star Tower , No. 6 Fenjiang Road, Foshan
City, China, Zip code: 528000

+86 13703061372
+86 13556051000

annawong_r1@163.com
benny_r1@163.com

<http://jxjkdz.com>

Since 2013

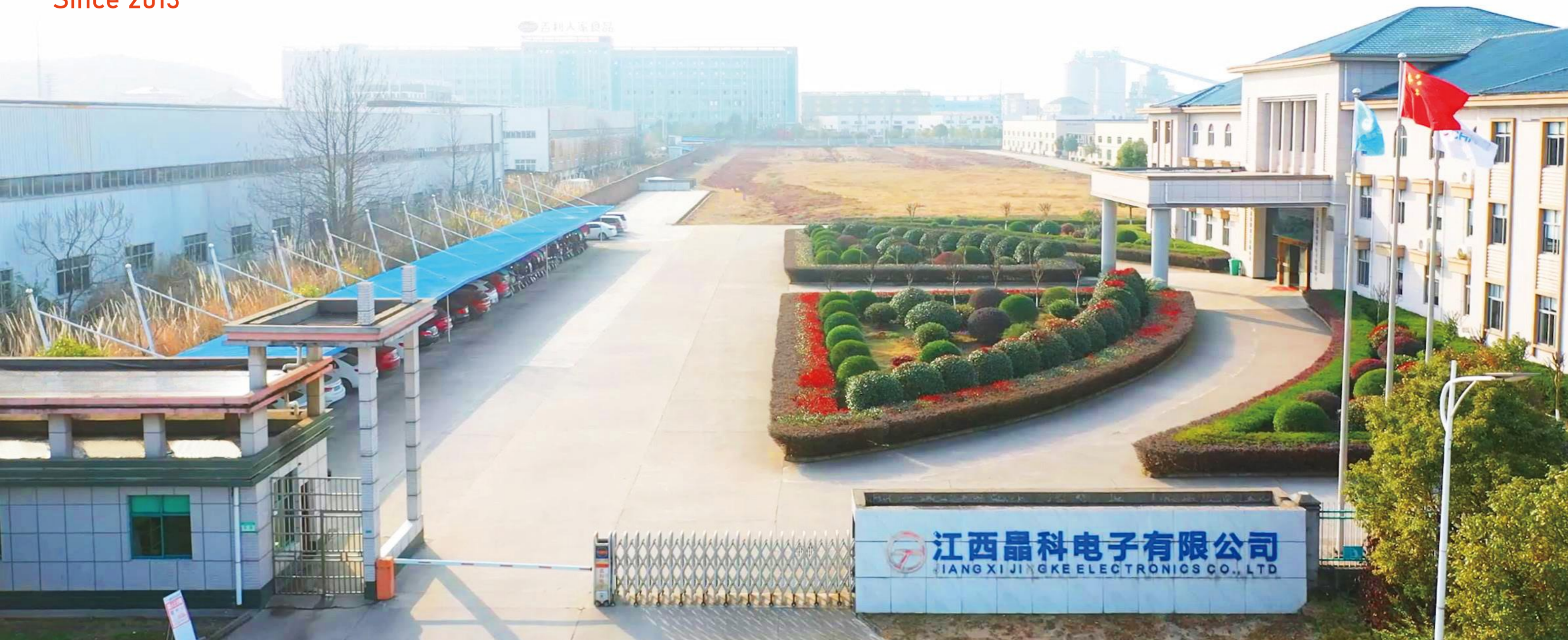

JINGKE was founded in 2013, it's a global comprehensive lighting manufacturer, credible supplier and service provider. We have our R&D team and production team with 400 employees, export to more than 80 countries in the world.

The company has its robust sales and service team. Through continuous innovation and sustainable development, JINKE strives to be a trusted OEM/ODM partner for all customers.



ENTERPRISE QUALIFICATIONS

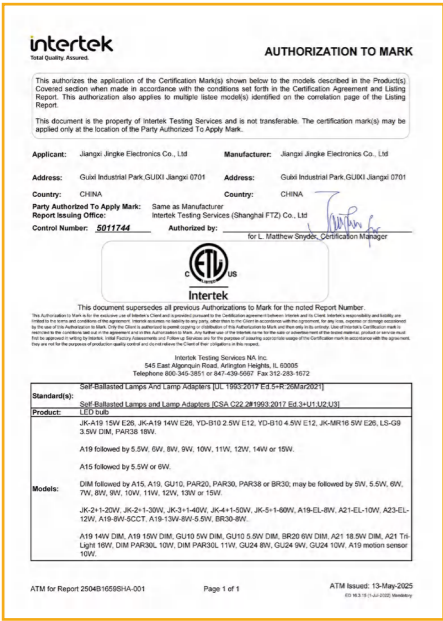
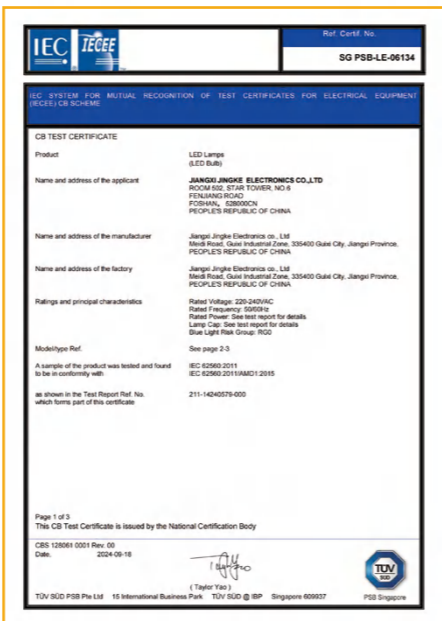
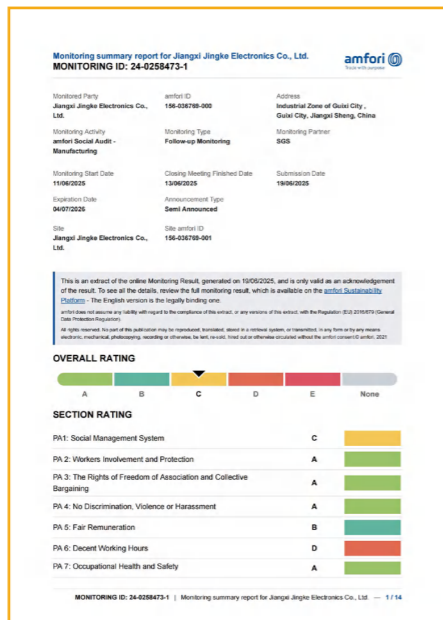

COMPANY OVERVIEW



Contents



LED Bulb.....	01-14
LED Garage Lamp.....	15-16
LED Strip.....	17-22
UV Light Series.....	23-24
LED Downlight.....	25-26
Flush Mount.....	27-30
Panel Light.....	31-32
Linear Light.....	33-34
Linear High Bay.....	35
UFO Light.....	36
T5 battens.....	37-38
Smart Light.....	39-42



LED BULB

LED SMD A15 A19 A21

Features:

- LED High brightness chip
- High quality materials
- Saving energy
- Luminance uniformity



Dim/Non-dim, UL, CRI80										
ITEM NO.	Voltage	Power (w)	Lumen (lm)	CRI	EQV.	Beam angle (°)	Size (mm)	Life (Hrs)	Dim/Non-dim	Base
A15	120V	5.5W	450	80	40W	200°	50*81mm	15000	Dim	E26
A15	120V	5.5W	450	80	40W	200°	50*81mm	15000	Non-dim	E26
A19	120V	6W	450	80	40W	200°	60*104mm	15000	Dim/Non-dim	E26
A19	120V	9W	806	80	60W	200°	60*104mm	15000	Dim/Non-dim	E26
A19	120V	11W	1050	80	75W	200°	60*108mm	15000	Dim/Non-dim	E26
A19	120V	12W	1100	80	75W	200°	60*108mm	15000	Dim/Non-dim	E26
A19	120V	14W	1500	80	100W	200°	60*117mm	15000	Dim/Non-dim	E26
A19	120V	15W	1600	80	100W	200°	60*117mm	15000	Dim/Non-dim	E26
A19	120V	10W	8000	80	60W	200°	60*95mm	15000	Non-dim	GU24



UL, CRI90										
ITEM NO.	Voltage	Power (w)	Lumen (lm)	CRI	EQV.	Beam angle (°)	Size (mm)	Life (Hrs)	Dim/Non-dim	Base
A19	120V	5W	450	90	40W	200°	60*104mm	15000	Dim	E26
A19	120V	8.8W	806	90	60W	200°	60*104mm	15000	Dim	E26
A19	120V	12.2W	1100	90	75W	200°	60*108mm	15000	Dim	E26
A19	120V	17.5W	1600	90	100W	200°	60*117mm	15000	Dim	E26



Dim/Non-dim, UL, CRI80										
ITEM NO.	Voltage	Power (w)	Lumen (lm)	CRI	EQV.	Beam angle (°)	Size (mm)	Life (Hrs)	Dim/Non-dim	Base
A21	120V	18.5W	2000	80	125W	200°	50*81mm	25000	Dim	E26
A21-3-WAY	120V	4/11/16W	350/800/1500	80	30/60/100W	200°	71*140mm	15000	Non-dim	E26



A19 COLOR BULBS

Features:

- LED High brightness chip
- High quality materials
- Saving energy
- Luminance uniformity



Bug Light



Non-dim, UL, CRI80

ITEM NO.	Voltage	Power (w)	Lumen (lm)	CRI	EQV.	Beam angle (°)	Size (mm)	Life (Hrs)	Dim/Non-dim	Base
Blue/Red/Pink/ Purple/Black	120V	6W		90	40W	200°	60*104mm	15000	Non-dim	E26
A19 Bug Light	120V	5W	400	90	40W	200°	60*104mm	15000	Non-dim	E26
A19 Bug Light	120V	9W	800	90	60W	200°	60*104mm	15000	Non-dim	E26

A19 NIGHT LIGHT

Features:

- Two modes lights: sleep light and work light
- Saving energy
- Eye-friendly



Non-dim, UL, CRI80

ITEM NO.	Voltage	Power (w)	CRI	EQV.	Beam angle (°)	Size (mm)	Life (Hrs)	Dim/Non-dim	Base
A19	120V	5W	90	40W	200°	60*104mm	15000	Non-dim	E26

EMERGENCY LAMP DUST TO DAWN LAMPS



Dim/Non-dim, ETL, CRI80

ITEM NO.	Voltage	Power (w)	Lumen (lm)	CRI	EQV.	Beam angle (°)	Size (mm)	Life (Hrs)	Dim/Non-dim	Base
A19 emergency	120V	9W	800	80	60W	200°	63*114mm	15000	Non-dim	E26
A19 dust to dawn	120V	9W	800	80	60W	40°	63*114mm	15000	Non-dim	E26
BR30 dust to dawn	120V	8W	650	80	65W	40°	95*117mm	25000	Non-dim	E26

LED SMD BULB BR AC120V

Features:

- LED High brightness chip
- High quality materials
- Saving energy
- Luminance uniformity



Dimmable, UL, CRI80

ITEM NO.	Voltage	Power (w)	Lumen (lm)	CRI	EQV.	Beam angle (°)	Size (mm)	Life (Hrs)	Dim/Non-dim	Base
R16	120V	6W	450	80	45W	110°	63*95mm	25000	Dim	E26
R20	120V	6W	450	80	45W	110°	63*95mm	15000	Dim	E26
BR30	120V	8W	650	80	65W	110°	94*130mm	15000	Dim	E26
BR30	120V	8.5W	700	80	65W	100°	94*130mm	11000	Dim	E26

Dimmable, UL CRI90



ITEM NO.	Voltage	Power (w)	Lumen (lm)	CRI	EQV.	Beam angle (°)	Size (mm)	Life (Hrs)	Dim/Non-dim	Base
R20 7W UL+T20	120V	7W	525	90	50W	100°	63*95mm	25000	Dim	E26
BR30 8.5W UL+T20	120V	8.5W	700	90	65W	100°	95*131.8mm	25000	Dim	E26
BR30 12W UL+T20	120V	12W	950	90	75W	100°	95*131.8mm	25000	Dim	E26
BR30 85W UL+T20	120V	13.5W	1100	90	85W	100°	95*131.8mm	25000	Dim	E26
BR40 100W UL+T20	120V	15W	1400	90	100W	100°	127*158mm	25000	Dim	E26



LED GROW LIGHT

Features:

- LED High brightness chip
- High quality materials
- Saving energy
- luminance uniformity

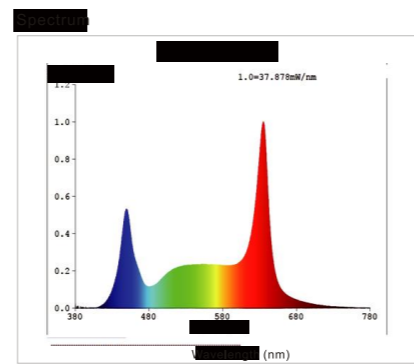

Color clear filament lamp , Non-dim, UL+FCC

ITEM NO.	Voltage	Power (w)	Lumen (lm)	PPE(umol/J)	PPF(umol/s)	Size (mm)	Non-dim	Base
A19	120V	9W	800	1.4umol/J	12umol/s	60*108mm	YES	E26
BR30	120V	8W	650	1.3umol/J	12umol/s	94*130mm	YES	E26

LED SMD BULB GU10

Features:

- LED High brightness chip
- High quality materials
- Saving energy
- luminance uniformity

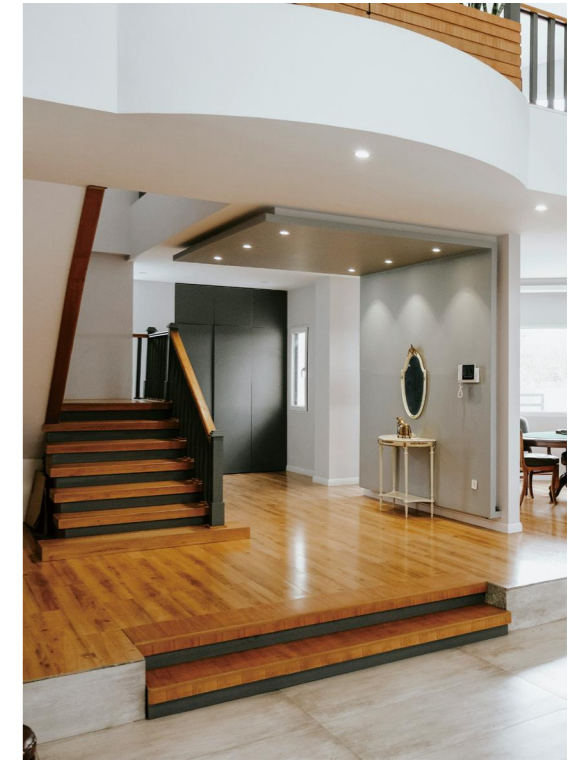

Dim UL, CRI80

ITEM NO.	Voltage	Power (w)	Lumen (lm)	CRI	EQV.	Beam angle (°)	Size (mm)	Life (Hrs)	Dim/Non-dim	Base
Glass GU10	120V	5W	420	≥80	50W	38°	50*56mm	25000	Dim	GU10
PC GU10	120V	5W	420	≥80	50W	38°	50*56mm	25000	Dim	GU10
PC MR16	12V	5W	420	≥80	50W	38°	50*48mm	25000	NON-Dim	GU5.3



Dim UL, CRI90

ITEM NO.	Voltage	Power (w)	Lumen (lm)	CRI	EQV.	Beam angle (°)	Size (mm)	Life (Hrs)	Dim/Non-dim	Base
Glass GU10	120V	5.5W	400	≥90	50W	38°	50*56mm	25000	Dim	GU10
PC GU10	120V	6.5W	500	≥90	50W	38°	50*56mm	25000	Dim	GU10

LED SMD BULB PAR

Features:

- LED High brightness chip
- High quality materials
- Saving energy
- luminance uniformity



Dim, UL, CRI80										
ITEM NO.	Voltage	Power (w)	Lumen (lm)	CRI	EQV.	Beam angle (°)	Size (mm)	Life (Hrs)	Dim	Base
PAR20	120V	7W	500	80	50W	40°	63*77mm	15000	Dim	E26
PAR30	120V	11W	800	80	75W	40°	122*132mm	15000	Dim	E26
PAR38	120V	14W	1200	80	90W	40°	122*132mm	15000	Dim	E26



Dim, UL, CRI80										
ITEM NO.	Voltage	Power (w)	Lumen (lm)	CRI	EQV.	Beam angle (°)	Size (mm)	Life (Hrs)	Dim	Base
PAR20 50W	120V	6.5W	520	90	50W	5°/140°	63*77mm	25000	Dim	E26
PAR30 90W-SN	120V	13W	1050	90	75W	25°/40°/60°	122*132mm	25000	Dim	E26
PAR30 90W-LN	120V	13W	1050	90	75W	25°/40°/60°	122*132mm	25000	Dim	E26
PAR38 100W	120V	15W	1200	90	90W	25°/40°/160°	122*132mm	25000	Dim	E26
PAR38 120W	120V	17.5W	1400	90	120W	40°/160°	122*132mm	25000	Dim	E26

LED FILAMENT BULB

Features:

- "Edison" Style Light Bulbs
- Smooth, Controlled dimming down to 10%
- Clear & Amber finish
- Warm soft light in familiar incandescent bulb shapes
- Mercury free



Clear, 2700K/3000K/4000K/5000K, Dim/Non-dim, UL										
ITEM NO.	Voltage	Power (w)	Lumen (lm)	CRI	EQV.	PF	Size (mm)	Life (Hrs)	Dim/Non-dim	Base
A19 4W clear non-dimmable UL	120V	4W	450	80	40W	0.5	60*105	15000	Non-dim	E26
A19 7W clear non-dimmable UL	120V	7W	800	80	60W	0.5	60*105	15000	Non-dim	E26
A19 9W clear non-dimmable UL	120V	9W	1050	80	75W	0.5	60*105	15000	Non-dim	E26
A19 12W clear non-dimmable UL	120V	12W	1500	80	100W	0.5	60*105	15000	Non-dim	E26
A19 4.5W clear dimmable UL	120V	4.5W	450	80	40W	0.7	60*105	15000	Dim	E26
A19 8W clear dimmable UL	120V	8W	800	80	60W	0.7	60*105	15000	Dim	E26
A19 9.5W clear dimmable UL	120V	9.5W	1100	80	75W	0.7	60*105	15000	Dim	E26
A19 13W clear dimmable UL	120V	13W	1600	80	100W	0.9	60*105	15000	Dim	E26
ST19 4.5W clear Dimmable UL	120V	4.5W	450	80	40W	0.7	56*125	15000	Dim	E26
ST19 5w clear Dimmable UL	120V	5W	500	80	60W	0.7	56*125	15000	Dim	E26
ST19 8W clear Dimmable UL	120V	8W	800	80	75W	0.7	56*125	15000	Dim	E26
ST21 4.5W clear Dimmable UL	120V	4.5W	450	80	40W	0.7	64*137	15000	Dim	E26
ST19 5W clear Dimmable UL	120V	5W	500	80	60W	0.7	64*137	15000	Dim	E26
ST21 8W clear Dimmable UL	120V	8W	800	80	/	0.7	64*137	15000	Dim	E26



B11 Clear



CA10 Clear



G16.5 Clear



G25 Clear

Clear , 2700K/3000K/4000K/5000K , Dim, UL

ITEM NO.	Voltage	Power (w)	Lumen (lm)	CRI	EQV.	PF	Size (mm)	Life (Hrs)	Dim	Base
B11 4W clear Dimmable UL	120V	4W	350	80	40W	0.7	35*97	15000	Dim	E26/E12
B11 5W clear Dimmable UL	120V	5.5W	500	80	60W	0.7	35*97	15000	Dim	E26/E12
CA10 4W clear Dimmable UL	120V	4W	350	80	40W	0.7	32*100	15000	Dim	E26/E12
CA10 5W clear Dimmable UL	120V	5.5W	500	80	60W	0.7	32*100	15000	Dim	E26/E12
G16.5 4W clear Dimmable UL	120V	4W	350	80	40W	0.7	50*78	15000	Dim	E26/E12
G16.5 5W clear Dimmable UL	120V	5.5W	500	80	60W	0.7	50*78	15000	Dim	E26/E12
G25 4W clear Dimmable UL	120V	4W	350	80	40W	0.7	80*113	15000	Dim	E26
G25 5.5W clear Dimmable UL	120V	5.5W	500	80	60W	0.7	80*113	15000	Dim	E26
G25 8W clear Dimmable UL	120V	8W	800	80	100W	0.7	80*113	15000	Dim	E26

Clear , 2700K/3000K/4000K/5000K , Dim/Non-dim , UL+T20

ITEM NO.	Voltage	Power (w)	Lumen (lm)	CRI	EQV.	PF	Size (mm)	Life (Hrs)	Dim/Non-dim	Base
A19 4.5W clear Dimmable UL+T20	120V	4.5W	450	90	40W	0.7	60*105	15000	Non-dim	E26
A19 8W clear Dimmable UL+T20	120V	8W	800	90	60W	0.7	60*105	15000	Non-dim	E26
A19 10.5W clear Dimmable UL+T20	120V	10.5W	1100	90	75W	0.7	60*105	15000	Non-dim	E26
A21 13.5W clear Dimmable UL+T20	120V	13.5W	1600	90	100W	0.7	67*113	15000	Non-dim	E26
ST21 5.5W clear Dimmable UL+T20	120V	5.5W	500	90	60W	0.7	56*125	15000	Non-dim	E26
ST21 5.5W clear Dimmable UL+T20	120V	5.5W	500	90	60W	0.7	64*137	15000	Non-dim	E26
B11 4W clear Dimmable UL+T20	120V	4W	360	80	40W	0.7	35*97	15000	Dim	E26/E12
B11 5.5W clear Dimmable UL+T20	120V	5.5W	500	80	60W	0.7	35*97	15000	Dim	E26/E12
CA10 4W clear Dimmable UL+T20	120V	4W	360	80	40W	0.7	32*100	15000	Dim	E26/E12
CA10 5.5W clear Dimmable UL+T20	120V	5.5W	500	80	60W	0.7	32*100	15000	Dim	E26/E12
G16.5 4W clear Dimmable UL+T20	120V	4W	360	80	40W	0.7	50*78	15000	Dim	E26/E12
G16.5 5W clear Dimmable UL+T20	120V	5.5W	500	80	60W	0.7	50*70	15000	Dim	E26/E12

LED FILAMENT BULB

Features:

- "Edison" Style Light Bulbs
- Smooth, Controlled dimming down to 10%
- Clear & Amber finish
- Warm soft light in familiar incandescent bulb shapes
- Mercury free



A19 Amber



ST19 Amber



ST21 Amber



B11 Amber



CA10 Amber



G16.5 Amber



G25 Amber

Amber, 2200K Dim/Non-dim UL

ITEM NO.	Voltage	Power (w)	Lumen (lm)	CRI	EQV.	PF	Size (mm)	Life (Hrs)	Dim/Non-dim	Base
A19 4.5W amber Dimmable UL	120V	4.5W	360	80	40W	0.7	60*105	15000	Non-dim	E26
A19 8W amber Dimmable UL	120V	8W	640	80	60W	0.7	60*105	15000	Non-dim	E26
A19 9.5W amber Dimmable UL	120V	9.5W	840	80	75W	0.7	60*105	15000	Non-dim	E26
A19 13W amber Dimmable UL	120V	13W	1200	80	100W	0.7	60*105	15000	Non-dim	E26
ST19 5.5W amber Dimmable UL	120V	5.5W	360	80	40W	0.7	56*125	15000	Dim	E26
ST19 8W amber Dimmable UL	120V	8W	650	80	60W	0.7	56*125	15000	Dim	E26
ST21 5.5W amber Dimmable UL	120V	5.5W	400	80	40W	0.7	64*137	15000	Dim	E26
ST21 8W amber Dimmable UL	120V	8W	650	80	60W	0.7	64*137	15000	Dim	E26
B11 4W amber Dimmable UL	120V	4W	280	80	40W	0.7	35*97	15000	Dim	E26/E12
ST19 8W amber Dimmable UL	120V	5.5W	400	80	60W	0.7	56*125	15000	Dim	E26/E12
CA10 4W amber Dimmable UL	120V	4W	280	80	40W	0.7	32*100	15000	Dim	E26/E12
CA10 5.5W amber Dimmable UL	120V	5.5W	400	80	60W	0.7	32*100	15000	Dim	E26/E12
G16.5 4W amber Dimmable UL	120V	4W	280	80	40W	0.7	50*78	15000	Dim	E26/E12
G16.5 5.5W amber Dimmable UL	120V	5.5W	400	80	60W	0.7	50*78	15000	Dim	E26/E12
G25 4W clear Dimmable UL	120V	4W	280	80	40W	0.7	80*113	15000	Dim	E26
G25 5.5W clear Dimmable UL	120V	5.5W	400	80	60W	0.7	80*113	15000	Dim	E26
G25 8W clear Dimmable UL	120V	8W	640	80	100W	0.7	80*113	15000	Dim	E26

LED FILAMENT BULB



Spiral type , 2200K , Dim/Non-dim , UL

ITEM NO.	Voltage	Power (w)	Lumen (lm)	CRI	EQV.	PF	Size (mm)	Life (Hrs)	Dim/Non-dim	Base
A19 5W amber Dimmable UL	120V	5W	250	80	25W	0.7	60*105	15000	Dim	E26
ST19 5W amber Dimmable UL	120V	5W	250	80	25W	0.7	56*125	15000	Dim	E26
ST21 5W amber Dimmable UL	120V	5W	250	80	25W	0.7	64*137	15000	Dim	E26
G25 5W amber Dimmable UL	120V	5W	250	80	25W	0.7	80*113	15000	Dim	E26
B11 5W amber Dimmable UL	120V	3W	125	80	25W	0.7	35*97	15000	Dim	E26
CA10 5W amber Dimmable UL	120V	3W	125	80	25W	0.7	32*100	15000	Dim	E26



S14 Clear



S14 Amber

Clear , 2700K

ITEM NO.	Voltage	Power (w)	Lumen (lm)	CRI	EQV.	PF	Size (mm)	Life (Hrs)	Dim/Non-dim	Base
S14 1W/CL	120V	1W	100	80	15W	0.4	φ45*85	15000	Non-dim	E26
S14 2W/CL	120V	2W	200	80	25W	0.5	φ45*85	15000	ELV compatible	E26

Clear , 2200K

ITEM NO.	Voltage	Power (w)	Lumen (lm)	CRI	EQV.	PF	Size (mm)	Life (Hrs)	Dim/Non-dim	Base
S14 1W/AM	120V	1W	100	80	15W	0.4	φ45*85	15000	Non-dim	E26
S14 2W/AM	120V	2W	200	80	25W	0.5	φ45*85	15000	ELV compatible	E26

LED FILAMENT BULB

Features:

- "Edison" Style Light Bulbs
- Smooth, Controlled dimming down to 10%
- Clear & Amber finish
- Warm soft light in familiar incandescent bulb shapes
- Mercury free



Clear , 2700K

ITEM NO.	Voltage	Power (w)	Lumen (lm)	CRI	EQV.	PF	Size (mm)	Life (Hrs)	Dim/Non-dim	Base
T6 1W/CL	120V	1W	100	>80	15	0.4	φ 19*87	15000	Non-dim	E12
T6 2W/CL	120V	2W	190	>80	25	0.5	φ 19*87	15000	Non-dim	E12
T9 2.5W/CL	120V	2.5W	250	>80	25	0.8	φ28*130	15000	Dim	E26
T9 4W/CL	120V	4W	360	>80	40	0.8	φ 28*130	15000	Dim	E26
T9L 4W/CL	120V	4W	450	>80	40	0.8	φ 28*280	15000	Dim	E26
T10 2.5W/CL	120V	2.5W	250	>80	25	0.8	φ 32*100	15000	Dim	E26
T10 4W/CL	120V	4W	360	>80	40	0.8	φ 32*100	15000	Dim	E26
T10 7.5W/CL	120V	7.5W	800	>80	40	0.8	φ 32*100	15000	Dim	E26
T14 2.5W/CL	120V	2.5W	250	>80	25	0.8	φ 45*92	15000	Dim	E26
T14 4W/CL	120V	4W	360	>80	40	0.8	φ 45*93	15000	Dim	E26

Clear , 2000K

ITEM NO.	Voltage	Power (w)	Lumen (lm)	CRI	EQV.	PF	Size (mm)	Life (Hrs)	Dim/Non-dim	Base
T6 1W/AM	120V	1W	80	>80	15	0.4	φ 19*87	15000	Non-dim	E12
T6 2W/AM	120V	2W	180	>80	25	0.5	φ 19*87	15000	Non-dim	E12
T9 2.5W/AM	120V	2.5W	200	>80	25	0.8	φ28*130	15000	Dim	E26
T9 4W/AM	120V	4W	300	>80	40	0.8	φ28*130	15000	Dim	E26
T9L 4W/AM	120V	4W	350	>80	40	0.8	φ 28*280	15000	Dim	E26
T10 2.5W/AM	120V	2.5W	200	>80	25	0.8	φ 32*100	15000	Dim	E26
T10 4W/AM	120V	4W	300	>80	40	0.8	φ 32*100	15000	Dim	E26
T14 2.5W/AM	120V	2.5W	200	>80	25	0.8	φ 45*92	15000	Dim	E26
T14 4W/AM	120V	4W	300	>80	40	0.8	φ 45*93	15000	Dim	E26



LED FILAMENT BULB

Features:

- A19 clear glass design
- Suitable for outdoor use
- Dimmable



Color clear filament lamp , Dim, UL+FCC

ITEM NO.	Voltage	Power (w)	Lumen (lm)	CRI	EQV.	CCT	Size (mm)	Life (Hrs)	Dim	Base
A19/4.5W/R	120V	4.5W	100	>80	25W	Red	60*108	15000	YES	E26
A19/4.5W/G	120V	4.5W	190	>80	25W	Green	60*108	15000	YES	E26
A19/4.5W/B	120V	4.5W	250	>80	25W	Blue	60*108	15000	YES	E26

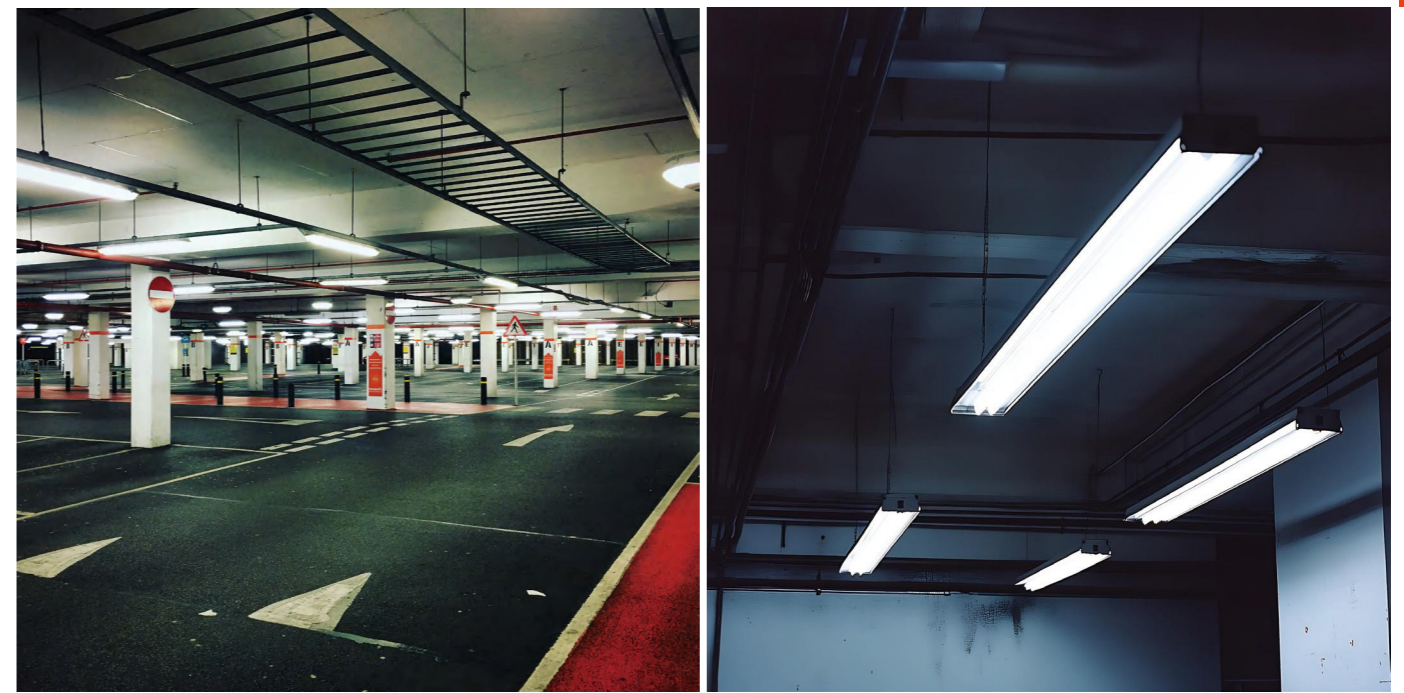

LED T8 TUBE(Type A)

Features:

- T8 Type A: easy Plug & Play performance
- Operates on instant start ballaste
- Double-ended

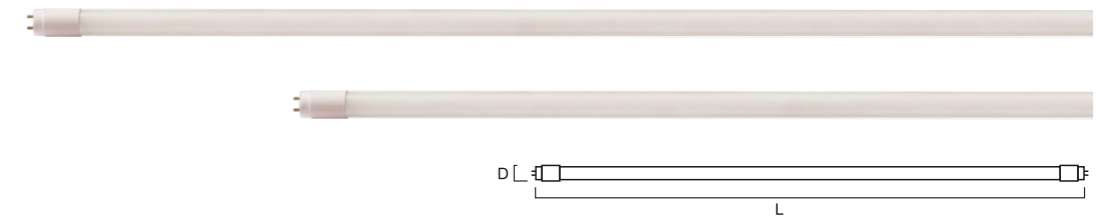

LED T8 Glass : Type A, UI+fcc

ITEM NO.	Voltage	Power (w)	Lumen (lm)	CRI	CCT	Beam angle (°)	Size (mm)	Life (Hrs)
2ft LED T8 8.5W	120V	8.5W	1350	83	3000K/4000K/5000K	270°	28*602	50000
4ft LED T8 11.5W	120V	11.5W	1650	83	3000K/4000K/5000K	270°	28*1212	50000
4ft LED T8 14W	120V	14W	1800	83	3000K/4000K/5000K	270°	28*1212	50000
4ft LED T8 18W	120V	18W	2000	83	3000K/4000K/5000K	270°	28*1212	50000



LED GARAGE LAMP

Features:

- With neck extender
- Adjusted up to 90 degrees
- Alu & PC housing

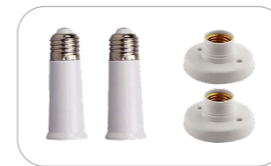

ITEM NO.	Voltage	Power (w)	Lumen (lm)	CRI	EQV.	Size (mm)	Life (Hrs)	Dim/Non-dim	Base
2 blades	120V	30W	3000	>80	250W	63*77mm	20000	Non-dim	E26
4 blades	120V	55W	5400	>80	300W	122*132mm	20000	Non-dim	E26
5 blades	120V	60w	5400	>80	330W	122*132mm	20000	Non-dim	E26

220V/120V/127V LED STRIP

FEATURES:

- PVC and Silicone types for choice
- PVC: IP65, for Eco purpose , 2 years warranty
- Silicone: IP65/IP67 , 3 years warranty
- With driver and driver free for options
- Reliable quality
- Indoor and outdoor use

SILICONE COAT AND IP CLASS

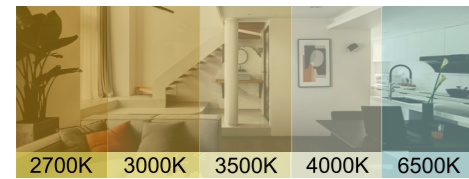
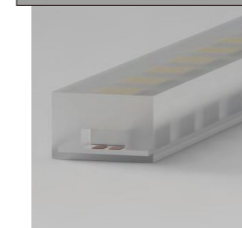
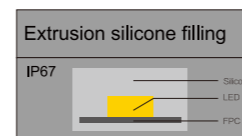
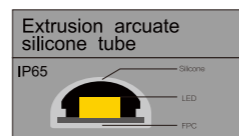

LED layout:



Type	Input voltage (V)	Regular Power (W)	Lumen (Lm/meter)	CRI	LED CHIP (SMD)	Led qty (pcs/meter)	CCT/Color	Size (H*Wmm)	Cutting (CM/cut)	IP grade	Material	Bending Diameter
Driver type	220/120V/127V VAC	8W	800	80	2835	120 Single line	3000/4000/6500K	5.8*11.8	10cm	IP65/IP67	PVC/Silicone	>60MM
	220/120V/127V VAC	9W	720	80	2835	120 Single line	3000/4000/6500K	6.5*11	20	IP65/IP67	PVC/Silicone	>60MM
	220/120V/127V VAC	11W	880	80	2835	120 Double line	3000/4000/6500K	6.5*14	20	IP65/IP67	PVC/Silicone	>60MM
	220/120V/127V VAC	9W	670	80	2835	120 Single line	3000/4000/6500K	5.8*11.8	100	IP65/IP67	PVC/Silicone	>60MM
	220/120V/127V VAC	11W	820	80	2835	120 Double line	3000/4000/6500K	6.3*14	100	IP65/IP67	PVC/Silicone	>60MM
	220/120V/127V VAC	14W	1100	80	2835	180 Double line	3000/4000/6500K	6.3*14	100	IP65/IP67	PVC/Silicone	>60MM
Driver free	220/120V/127V VAC	14W	1100	80	2835	180 Triple line	3000/4000/6500K	6.3*14	100	IP65/IP67	PVC/Silicone	>60MM
	220/120V/127V VAC	8W	/	80	5050	60led single line	RGB	6.3*15	100	IP65/IP67	PVC/Silicone	>60MM
	220/120V/127V VAC	8W	/	80	5050	96led Double line	RGB	6.3*16.8	100	IP65/IP67	PVC/Silicone	>60MM
	220/120V/127V VAC	8W	800	80	2835	120 Single line	3000/4000/6500K	5.8* 11.8	10cm	IP67	Silicone	>60MM
	220/120V/127V VAC	15W	286	80	2835	10*4.5mm	50	90	2700/3000/4000/6500K	IP65	3	>50MM
	220/120V/127V VAC	15W	260	80	2835	10*4.5mm	50	-	Y/G/B/R color	IP65	3	>50MM

Silicone: Eco-friendly material, featured in IP65/IP67, great UV protection, and can expose to intense sunlight without yellowing and aging for a long time

Accessories: Welcome for enquiry

COB LED strip

FEATURES:

- High efficacy from 80 -100LM per watt with high color rendering
- RA 80- 90 , SDCM<6
- Cutting length various for your convenient demand
- Reliable quality design with 20Z, long life with 3 years warranty
- COB led available with 288, 320 432 512, 672D
- FPC width available with 5, 8 and 10mm
- ERP compliance
- Indoor and outdoor use



Series	Voltage	POWER (w)	LEDs/m	FPC Width (mm)	mm cutting size	CRI	CCT/Color	IP	WARRANTY (Yrs)	Bending Diameter
Regular series:	24	11W	288	8mm	55.5	90	2700/3000/4000/6500K	IP20	3	>50MM
	24	9W	288	8mm	55.5	90	B/R/G/Y/P/ICE BLUE	IP20	3	>50MM
CLASSIC	24	13W	432	8mm	55.5	90	2700/3000/4000/6500K	IP20	3	>50MM
	24	15W	512	10mm	62.5	90	2700/3000/4000/6500K	IP20	3	>50MM
SUPER NARROW	24	10W	288	5mm	55.5	90	2700/3000/4000/6500K	IP20	3	>50MM
	24	12W	432	5mm	55.5	90	2700/3000/4000/6500K	IP20	3	>50MM
CCT 2700-6500K	24	12W	416	10mm	38	90	2700-6500K	IP20	3	>50MM
	24	15W	560	8mm	25	90	2700-6500K	IP20	3	>50MM
RGB	24	13W	672	10mm	62.5	-	RGB	IP20	3	>50MM
	-	11W(PVC)	288	8mm	250	80	2700/3000/4000/6500K	IP65	3	>50MM
220V/120V/127V	-	15W(PVC)	432	8mm	167	80	2700/3000/4000/6500K	IP65	3	>50MM
	-	11W(SIL)	288	8mm	250	80	2700/3000/4000/6500K	IP65	3	>50MM
	-	15W(SIL)	432	8mm	167	80	2700/3000/4000/6500K	IP65	3	>50MM
Driver Free	220/120V/127V VAC	15W	286	10*4.5mm	50	90	2700/3000/4000/6500K	IP65	3	>50MM
	220/120V/127V VAC	15W	260	10*4.5mm	50	-	Y/G/B/R color	IP65	3	>50MM

Accessories: Welcome for enquiry

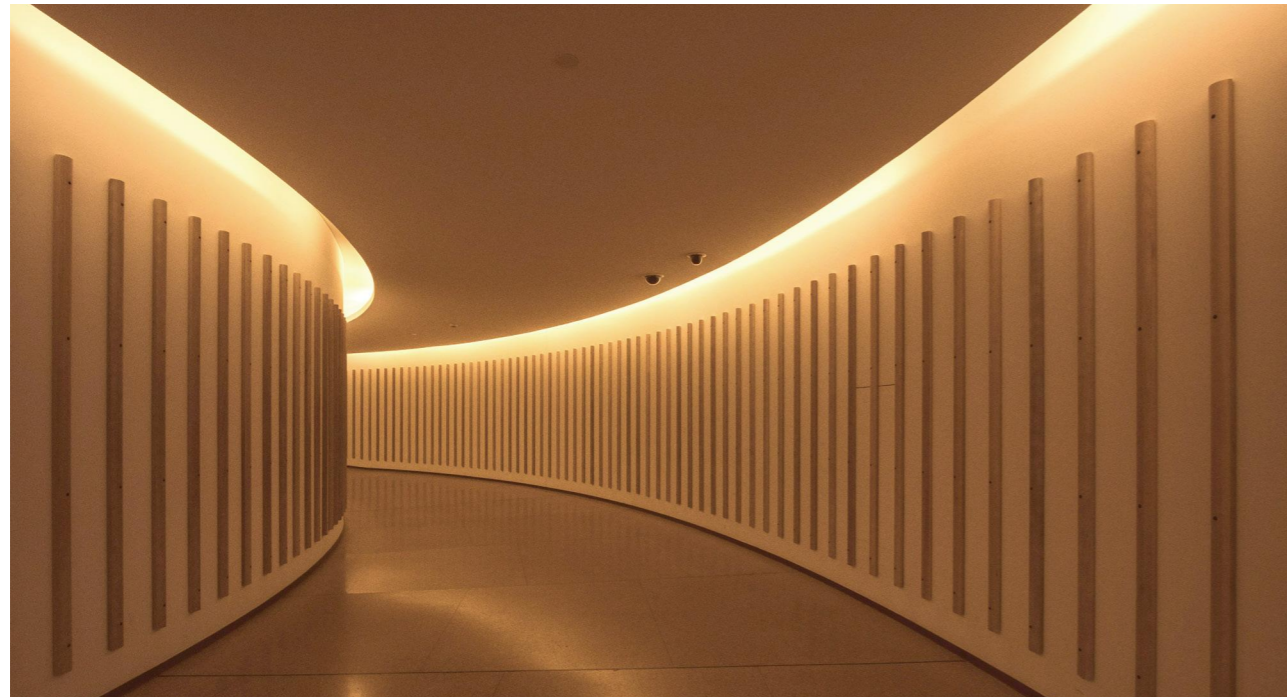

12V/24V/48V SMD LED STRIP LIGHT

FEATURES:

- Cutting from regular 5cm-10cm and any cut for choice
- Led layout from one line to 4 lines to meet different applications
- PCB width from 40-30-15-10-8mm and extremely narrow from 5-3mm to meet different markets
- Efficiency: from 80lm/W ->200 lm/W
- SDCM<6, RA80/RA90/RA95/RA98
- Reliable quality design with 2OZ/3OZ PFC, long life with 3 years warranty
- Bending diameter more than 50mm
- Available with 48V extra long, no vol drop max to 30 meters long
- Indoor and outdoor use

LED layout:

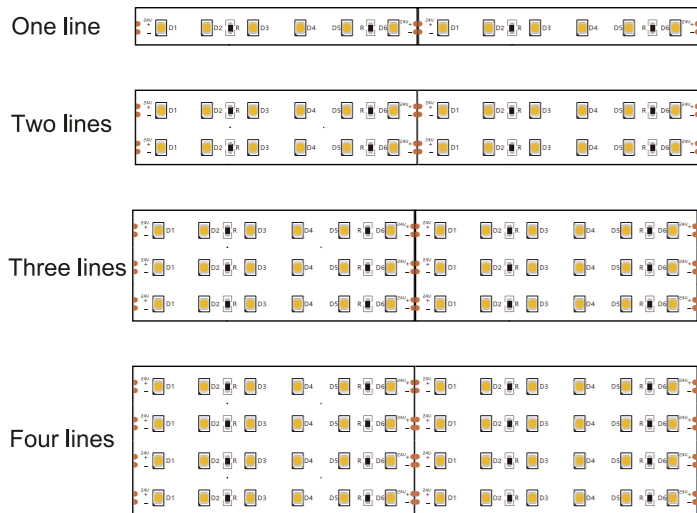

Regular series:										
Series	Product description	Voltage	W/m	LEDs/m	PCB Width (mm)	cm cutting size	CRI	CCT/Color	SDCM	Bending Diameter
Regular series: Classic 80-110lm/W	12V-2835-60D-8MM IP20	12	5	60	8	5cm	80-90	2700/3000/4000/6500K	>6	>60MM
	12V-2835-120D-8MM IP20	12	10	120	8	5cm	80-90	2700/3000/4000/6500K	>6	>60MM
	12V-2835-120D-8MM IP20	24	5	60	8	10cm	80-90	2700/3000/4000/6500K	>6	>60MM
	24V-2835-120D-8MM IP20	24	9	120	8	5cm	80-90	2700/3000/4000/6500K	>6	>60MM
	24V-2835-120D-10MM IP20	24	9	120	10	5cm	80-90	2700/3000/4000/6500K	>6	>60MM
	24V-5050-60D-10MM IP20	24	12	60	10	10cm	80-90	2700/3000/4000/6500K	>6	>60MM
High efficiency 140lm/w	24V-2835-126D-8MM IP20	12	8	126	8	5.55cm	80-90	2700/3000/4000/6500K	>6	>60MM
	24V-2835-168D-10MM IP20	12	12	168	10	4.16cm	80-90	2700/3000/4000/6500K	>6	>60MM
	24V-2835-238D-10MM IP20	24	20	238	10	2.94cm	80-90	2700/3000/4000/6500K	>6	>60MM
	24V-2835-238D-15MM IP20 2 lines	24	24	240	15	2.5cm	80-90	2700/3000/4000/6500K	>6	>60MM
	24V-2835-378D-30MM IP20 3 lines	24	35	378	30	5.55cm	80-90	2700/3000/4000/6500K	>6	>60MM
	24V-2835-504D-40MM IP20 4 lines	24	45	504	40	5.55cm	80-90	2700/3000/4000/6500K	>6	>60MM

Speical features series:										
Series	Product description	Voltage	W/m	LEDs/m	PCB Width (mm)	cm cutting size	CRI	CCT/Color	SDCM	Bending Diameter
Regular series: CCT (2700-6500K)	24V-2835-120D-8MM Dual colors IP20	24	12	120	8	10cm	80-90	Dual colors	>6	>60MM
	24V-2835-120D-8MM Dual colors 2IN1 IP20	24	16	120	8	Any cut	80-90	Dual colors	>6	>60MM
	24V-2835-192D-8MM Dual colors IP20	24	12	192	8	6.25cm	80-90	2700/3000/4000/6500K	>6	>60MM
	24V-2835-240D-15MM Dual colors IP20	24	20	240	15	25cn	80-90	2700/3000/4000/6500K	>6	>60MM
48V Extra long (30meters without vol. drop)	48V-2835-120D-10MM IP20 1 lines	48	15	120	10	6.25cm	80-90	2700/3000/4000/6500K	>6	>60MM
	48V-2835-240D-15MM IP20 2 lines	48	30	240	15	6.25cm	80-90	2700/3000/4000/6500K	>6	>60MM
SPI (Running Color)	24V-2835-120D-10MM DSPM IP20	24	10	120	10	12.5cm	80-90	2700/3000/4000/6500K	>6	>60MM
	24V-2835-120D-8MM DSPM IP20	24	10	120	8	12.5cm	80-90	2700/3000/4000/6500K	>6	>60MM
	24V-5050-60D-10MM SPI RGB IP20	24	13	60	10	10cm	/	RGB	/	>60MM
DMX	24V-2835-96D-10MM SPI RGB IP20	24	13	60	8	10cm	/	RGB	/	>60MM
	24V-5050-60D-10MM DMX RGB IP20	24	13	60	10	10cm	/	RGB	/	>60MM
	24V-5050-60D-12MM DMX RGBW IP20	24	17	60	12	10cm	/	3 in 1 RGBW	/	>60MM

Accessories: Welcome for enquiry



NEON LED STRIP

NEON LED STRIP

FEATURES:

- Durable and energy efficient lighting
- Flexible design for easy installation
- High quality silicone material that provides excellent resistance to water, heat, and UV radiation
- PVC option for ECO purpose



Series	Model no.	V	W/m	LM/m (4000K)	CRI	CCT/Color	SDCM	Product size (W*Hmm)	Life (hrs)	Cut size (mm)	Bending dia. (mm)	IP
Top bend	NEON24-S-67 2110-238L-24V (6*7mm)one side light	24	8	500	>80	6500-4000-3000K	<6	6*7	L20000	30	>60°	IP67
Side bend	NEON24-S-612 2835-120L-24V small U: silicone (6*12mm)	24	10	350	>80	6500-4000-3000K	<6	6*12	L20000	at will	>60°	IP67
		24			\	RGB	\	6*12	L20000	\	>60°	IP67
Side bend	NEON24-S-816 2835-120L-24V (8*16mm)	24	8	800	>80	6500-4000-3000K	<6	8*16	L20000	at will	>60°	IP67
		24	\	\	\	RGB	\	8*16	L20000	\	>60°	IP67
Top bend	NEON24-S-0907 2835-120L-24V (9*7mm)one side light	24	12	500	>80	6500-4000-3000K	<6	10*10	L20000	at will	>60°	IP67
Top bend	NEON24-S-1010 2835-120L-24V (10*10mm)Three sided light	24	12	1000	>80	6500-4000-3000K	<6	10*10	L50000	at will	>60°	IP67
Side bend	NEON24-S-1010 2835-120L-24V (10*10mm)One sided light	24	12	1000	>80	6500-4000-3000K	<6	10*10	L50000	at will	>60°	IP67
Side bend	NEON24-S-1115 2835-120L-24V (11*15mm)	24	12	450	>80	6500-4000-3000K	<6	11*15	L20000	at will	>60°	IP67
Top bend	NEON24-S-1220 2835-120L-24V 12*20mm)one side light	24	12	800	>80	6500-4000-3000K	<6	12*20	L10000	at will	>60°	IP67
		24	8	\	\	RGB	\	12*20	L10000	\	>60°	IP67
Top bend	NEON24-S-1616 2835-120L-24V 16*16mm)one side light	24	12	400	>80	6500-4000-3000K	<6	16*16	L20000	at will	>60°	IP67
		24	\	\	\	SPI(RGB RUNNING)	\	16*16	L20000	\	>60°	IP67
		24	\	\	\	DMX	\	16*16	L20000	\	>60°	IP67
Top bend	NEON24-S-3020 2835-120L-24V 30*20mm)one side light	24	12	800	>80	6500-4000-3000K	<6	30*20	L10000	50	>60°	IP67
PVC NEON	CN-612-2835-120D	120/127V	9	260	>80	6500-4000-3000K	<6	6*12	L15000	100	>60°	IP67
	CN-816-2835-120D	120/127V	9	260	>80	6500-4000-3000K	<6	8*16	L15000	100	>60°	IP67
	CWNEON24-S-612 NANO	24	10	350	>80	6500-4000-3000K	<6	6*12	L20000	at will	>60°	IP67

Recommended Accessories:

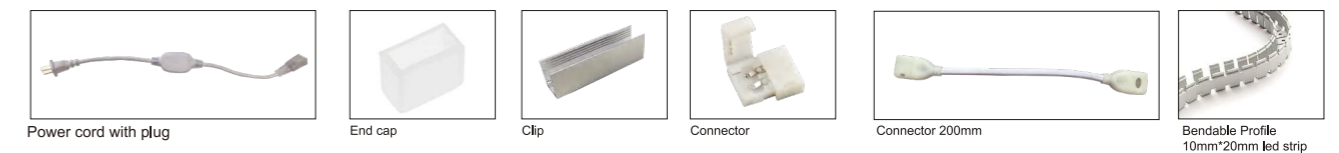

UVA Lamp

UVA Spectrum

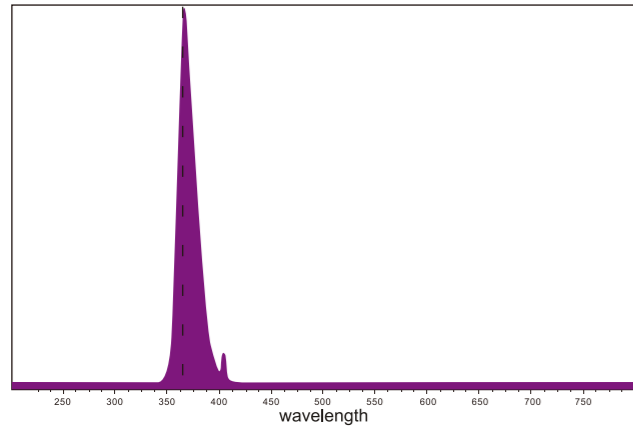

UVA CFL Black light tube Spectrum

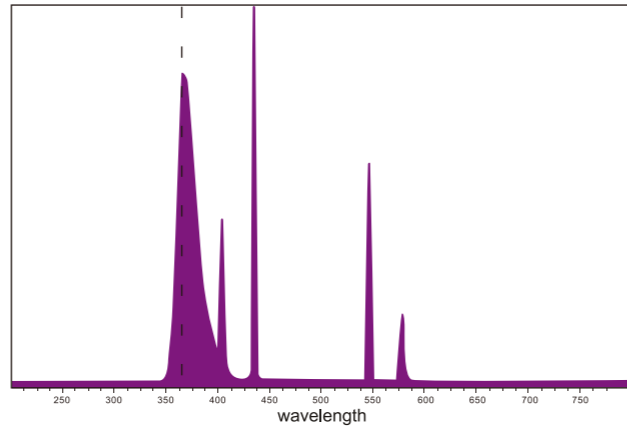

UVA CFL White light tube Spectrum

Application area: Hotel restaruant farm



T5



Series	Model	Wattage	Voltage(V)	Current(mA)	Life(h)	Irradiation intensity at 365nm(1m)($\mu\text{w}/\text{cm}^2$)	Pin to pin length(mm)	Base
T5 White tube	UVA-T5-4WBL-Z150	4W	25	130	8000	8.7	150	G5
	UVA-T5-6WBL-Z226	6W	40	120	8000	12.1	226	G5
	UVA-T5-8WBL-Z302	8W	55	110	8000	13.8	302	G5

T8



Series	Model	Wattage	Voltage(V)	Current(mA)	Life(h)	Irradiation intensity at 365nm(1m)($\mu\text{w}/\text{cm}^2$)	Pin to pin length(mm)	Base
T8 White tube	UVA-T8-10WBL-Z345	10W	40	210	8000	22.8	345	G13
	UVA-T8-15WBL-Z451	15W	50	305	8000	43.5	451	G13
	UVA-T8-20WBL-Z604	20W	55	305	8000	54.8	604	G13
T8 LED Tube	LED UVA T8-5W-Z331	5W	100-265V	52	15000	/	11.3	G13
	LED UVA T8-7W-Z437	7W	100-265V	61	15000	/	17.8	G13
	LED UVA T8-10W-Z589	10W	100-265V	85	15000	/	20	G13



Remote Downlight

Features:

- 2700K/3000K/3500k/4000k/5000k Adujstable
- 90% Triac dimmer support
- Easy intall



Product Model	Dimension	Input Voltage	Power	Dimmable	Light Efficiency	CRI	CCT	Matrials
CN-04-11-5CT	φ132*H45mm	120V	11W	Triac	82LPW	90	5CCT Adjust	Iron+PC
CN-06-15-5CT	φ187*H64mm	120V	15W	Triac	82LPW	90	5CCT Adjust	Iron+PC Diffuse

Remote Downlight

Features:

- 2700K/3000K/3500k/4000k/5000k Selectable
- 90% Triac dimmer support
- Easy intall



Product Model	Dimension	Input Voltage	Power	Dimmable	Light Efficiency	CRI	CCT
CN-04-11-5CT	φ128*25.4mm	120V	11W	Triac	82LPW	90	5CCT Adjust
CN-06-14-5CT	φ178*25.4mm	120V	14W	Triac	82LPW	90	5CCT Adjust
CN-08-27-5CT	φ230*H28mm	120V	25W	Triac	82LPW	90	5CCT Adjust



Product Model	Dimension	Input Voltage	Power	Dimmable	Light Efficiency	CRI	CCT
CN-04-10-6CT-Night light	φ135*H47mm	120V	10.5W	Triac	82LPW	90	5CCT Selectable
CN-06-14-6CT-Night light	φ184*H48mm	120V	14W	Triac	82LPW	90	5CCT Selectable



FLUSH MOUNT(Acrylic)

Features:

- Contemporary Design
- Integrated LED Modules
- Multiple colors for Choice
- Damp Location
- Dimmable down to 10%
- 3CCT and 5CCT available
- CRI80 and CRI90 available



10" / 12" / 14" / 16"



6"-15W

70 lumens per watt /85 lumens per watt



Item No.	Power (W)	Input Voltage(V)	Luminous (LM)	CCT	CRI	PF	Dimension (mm)	Lifetime (Hrs)
10"-15W	15W	AC120V	1050	5000K	80	0.9	D11.02**H3.5"	50000
12"-18W	18W	AC120V	1260	5000K	80	0.9	D13.77**H3.7"	50000
14"-24W	24W	AC120V	1680	5000K	80	0.9	D15.94**H3.9"	50000
16"-28W	28W	AC120V	1960	5000K	80	0.9	D15.94**H3.9"	50000

Item No.	Power (W)	Input Voltage(V)	Luminous (LM)	CCT	CRI	PF	Dimension (mm)	Lifetime (Hrs)
6"-15W	15W	AC120V	1050	3000K/4000K/5000K	80	>0.9	D7.2"	50000
6"-15W	15W	AC120V	1260	3CCT Selectable	80	>0.9	D7.2"	50000

Metal + Acrylic cover, ETL



Power(W) : 24W
Input Voltage : AC120V
Luminous(LM) : 1680lm
CCT : 4000K
CRI : 90
Color : BN
Dimension(mm) : W16**H5"
Lifetime(Hrs) : 50000
Material : Steel+Acrylic+Cloth



Power(W) : 20W
Input Voltage : AC120V
Luminous(LM) : 1400
CCT : 3000K
CRI : 90
Color : ORB+WH / BK+WH / WH
Dimension(mm) : D19.7**H5.5"
Lifetime(Hrs) : 50000
Material : Steel+Acrylic



Power(W) : 22W
Input Voltage : AC120V
Luminous(LM) : 1540lm
CCT : 4000K
CRI : 90
Color : BK+AG
Dimension(mm) : W16**H8 / 11**E3.8"
Lifetime(Hrs) : 50000
Material : Steel+Acrylic



Power(W) : 30W
Input Voltage : AC120V
Luminous(LM) : 2100
CCT : 3000K
CRI : 90
Color : BK+AG
Dimension(mm) : W17.75**H4"
Lifetime(Hrs) : 50000
Material : Steel+Acrylic



Power(W) : 20W / 25W
Input Voltage : AC120V
Luminous(LM) : 1300 / 1600
CCT : 5CCT (2700K-5700K)
CRI : 80
Color : Nickel/White/Black
Dimension(mm) : W12.8**H2.3" / W15.7**H2.3"
Lifetime(Hrs) : 50000
Material : Steel+Acrylic



Power(W) : 20W / 25W
Input Voltage : AC120V
Luminous(LM) : 1300 / 1600
CCT : 5CCT (2700K-5700K)
CRI : 80
Color : Nickel/White/Black
Dimension(mm) : W12.8**H2.3" / W15.7**H2.3"
Lifetime(Hrs) : 50000
Material : Steel+Acrylic



SLIM PANEL

Features:

- Edgelite design, slim profile
- CCT selectable , with nightlight option
- Easy and safety installation
- High Brightness with efficient LEDs and Driver
- ETL Approved, Wet-Rated
- Smooth, Uniform Dimmable : 10%-100% dimming range
- Plastic housing/Alu housing with PS diffuser, Iron back
- Compatible with most household triac
- LED dimmers for smooth and flicker-free operation



7.5" (Φ 190mm) 13" (Φ 325mm) 18" (Φ 457mm)

White, silver and ORB colors available



Power	Luminous Efficiency	Luminous Flux(LM)	CCT	DIMENSION	Mode
15+3W	100LM/W	1500LM	3CCT+Night Light 2000K	7.5"	Night Light
15+3W	100LM/W	1500LM	3CCT+Night Light 2000K	7.5"	Motion Sensor
24W	100LM/W	2400LM	3CCT	13"	Normal
24+4W	100LM/W	2400LM	3CCT+Night Light	13"	Night Light
24+4W	100LM/W	2400LM	3CCT+Night Light (edge)	13"	Night Light
24W	100LM/W	2400LM	RGBCW	13"	Tuya Smart
32W	100LM/W	3200LM	3CCT	18"	Normal
32+4W	100LM/W	3200LM	3CCT+Night Light	18"	Night Light
38W	100LM/W	3800LM	3CCT	32"	Normal
38+4W	100LM/W	3800LM	3CCT+Night Light 2000K	32"	Night Light

Optional Installation Instructions Installed directly on the ceiling

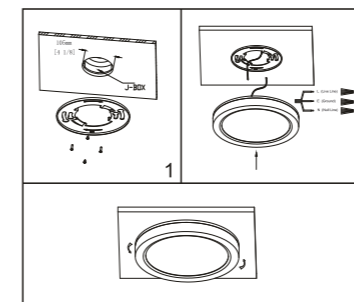

Installation over standard electrical junction box

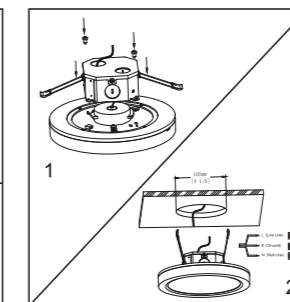

Installation onto existing 5 inch or 6 inch recessed housings

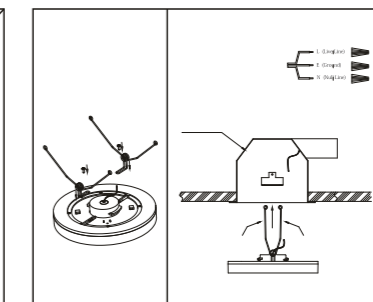

SELECTING MAIN LIGHT
OR NIGHT LIGHT MODE:

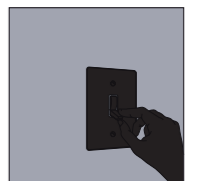

By Wall Switch



Linear Light

Features:

- Light efficiency is reach to 110lm/W.
- 3000K/4000K/5000K Selectable
- 100-277V universal voltage
- White/Black color Body

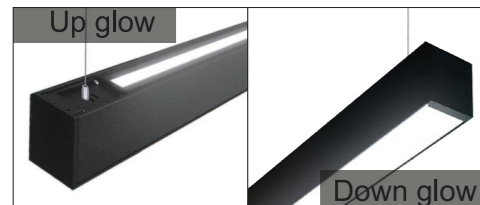
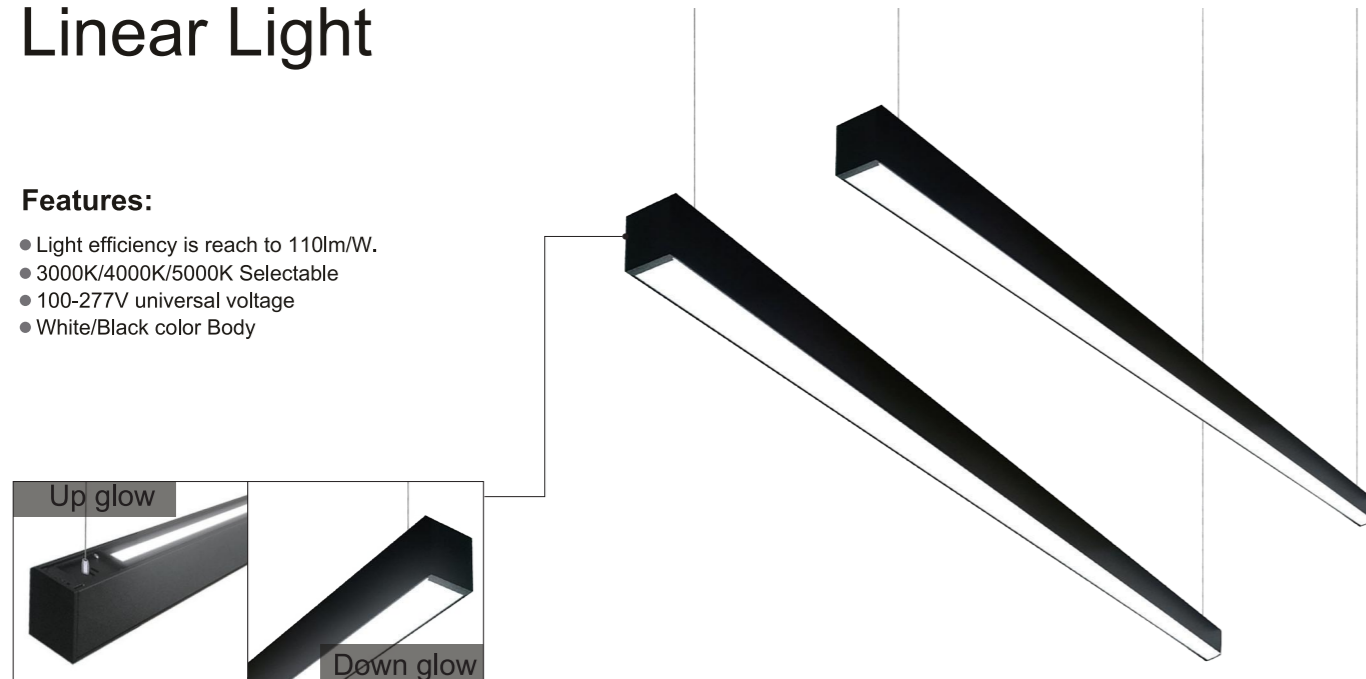

Product Model	Input Voltage	Power	Lumens	Beam Angle	Dimmable	Dimension	Light Efficiency	CCT	Finish
CN-LS-40-3CT-4FT	100-277VAC	30/40/50W	4400LMS	120°	0-10V Dimmable	1200*55*75mm	110LPW	3000K/4000K/5000K Selectable	PC+Aluminum
CN-LS-40-4CT-4FT	100-277VAC	30/40/50W+15W	4400LMS	120°	0-10V Dimmable	1200*55*75mm	110LPW	3000K/4000K/5000K(Glow down) 3000K/4000K/5000K(Glow UP)	PC+Aluminum
CN-LS-100-3CT-8FT	100-277VAC	60/80/100W	4400LMS	120°	0-10V Dimmable	2400*55*75mm	110LPW	3000K/4000K/5000K Selectable	PC+Aluminum
CN-LS-100-4CT-8FT	100-277VAC	60/80/100W+30W	4400LMS	120°	0-10V Dimmable	2400*55*75mm	110LPW	3000K/4000K/5000K(Glow down) 3000K/4000K/5000K(Glow UP)	PC+Aluminum
Special-Shaped	100-277VAC	9W	9900LMS	120°	0-10V Dimmable	150*55*75mm	110LPW	3000K/4000K/5000K	Aluminum
Special-Shaped	100-277VAC	9W	9900LMS	120°	0-10V Dimmable	225*55*75mm	110LPW	3000K/4000K/5000K	Aluminum
Special-Shaped	100-277VAC	13W	1430LMS	120°	0-10V Dimmable	245*150*75mm	110LPW	3000K/4000K/5000K	Aluminum
Special-Shaped	100-277VAC	13W	1430LMS	120°	0-10V Dimmable	268*268*75mm	110LPW	3000K/4000K/5000K	Aluminum
Plug cable	/	/	/	/	/	L:16mm	/	/	/
Accessory for hanging	/	/	/	/	/	L:1.5Mmm	/	/	/
Accessory for ceiling (surfacemounted)	/	/	/	/	/	/	/	/	/

Installation

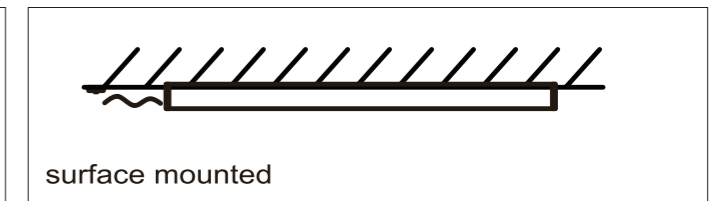
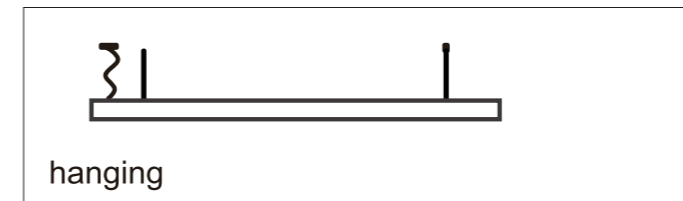

Accessory

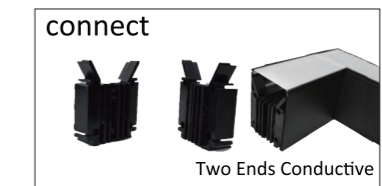
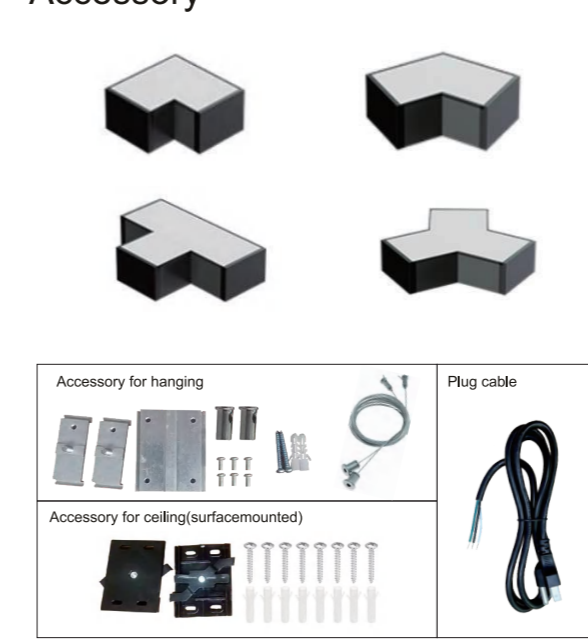

Linear High Bay

Features:

- 1. Light efficiency is reach to 120lm/W
- 2. 120-277V universal voltage
- 3. 5 years warranty
- 4. 0-10V Dimmable

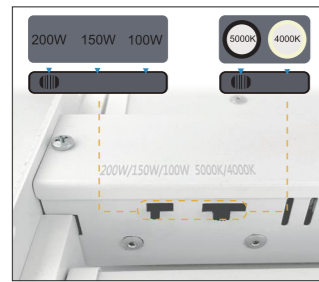
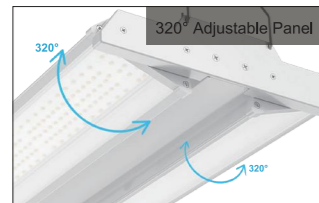

Product Model	Input Voltage	Power	Lumens	Beam Angle	Dimmable	Dimension	Light Efficiency	CCT
CNLFS-150	120-277VAC	150W	18000LMS	320°adjustable	0-10V Dimmable	410*266*46mm	120LPW	3000K/4000K/5000K
CNLFS-200	120-277VAC	200/150/100W Adjustable	24000LMS	320°adjustable	0-10V Dimmable	600*266*46mm	120LPW	4000K/5000K Adjustable
CNLFS-300	120-277VAC	300/240/200W Adjustable	40000LMS	320°adjustable	0-10V Dimmable	900*266*46mm	120LPW	4000K/5000K Adjustable

UFO Light

Features:

- 1. Instantly lit up - providing instant bright light
- 2. Commercial grade - IP65 waterproof and shatterproof casing
- 3. Lightweight die cast aluminum shell design suitable for indoor or outdoor use

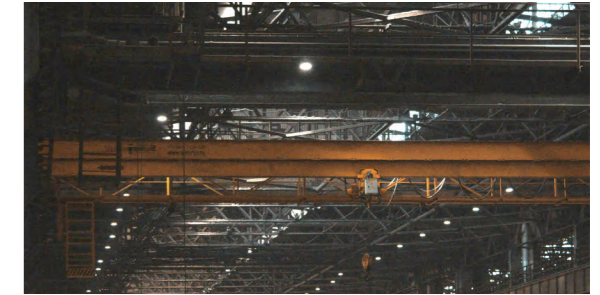

Product Model	Input Voltage	Power	Lumens	Beam Angle	CRI	NON-DIM	Dimension	Light Efficiency	CCT
KLHB-WCER2-XXK	120-277VAC	150W	2100LMS	120°	80	NO	Φ313*80mm	100LPW	3000K/4000K/5000K/5700K



Product Model	Input Voltage	Power	Beam Angle	Dimmable	Dimension	Light Efficiency	CCT
CNXXXWCS2	100-277VAC	80W/100W/120W Tunable	120°	0-10V Dimmable	Φ313*107mm	140LPW	4000K/5000K/6000K Tunable
CNXXXWCS2	100-277VAC	90W/120W/150W Tunable	120°	0-10V Dimmable	Φ313*107mm	140LPW	4000K/5000K/6000K Tunable
CNXXXWCS2	100-277VAC	120W/160W/200W Tunable	120°	0-10V Dimmable	Φ313*107mm	140LPW	4000K/5000K/6000K Tunable
CNXXXWCS2	100-277VAC	150/200/240W Tunable	120°	0-10V Dimmable	Φ313*107mm	140LPW	4000K/5000K/6000K Tunable
CNUFO-25170-YY	100-277VAC	25W	Emergency Battery				
CNUFO-40170-YY	100-277VAC	40W	Emergency Battery				



T5 battens

T5 battens

T5 battens



Product Model	Input Voltage	Power	Lumens	Beam Angle	Life (Hrs)	Dimension	Light Efficiency	CCT	Finish
T5 battens 0.3m-3CCT	100-277VAC	4W	440LM	210°	50000	235*25*35mm	110LPW	4000K-5000K-6000K	AL+PC
T5 battens 0.4m-3CCT	100-277VAC	4W	440LM	210°	50000	355*25*35mm	110LPW	4000K-5000K-6000K	AL+PC
T5 battens 0.6m-3CCT	100-277VAC	7W	770LM	210°	50000	570*25*35mm	110LPW	4000K-5000K-6000K	AL+PC
T5 battens 0.9m-3CCT	100-277VAC	12W	13200LM	210°	50000	870*25*35mm	110LPW	4000K-5000K-6000K	AL+PC
T5 battens 1.2m-3CCT	100-277VAC	16W	1650LM	210°	50000	1176*25*35mm	110LPW	4000K-5000K-6000K	AL+PC
T5 battens 1.5m-3CCT	100-277VAC	20W	2200LM	210°	50000	1473*25*35mm	110LPW	4000K-5000K-6000K	AL+PC

Accessory





Smart light

SMART FILAMENT

Features:

- Easy to install
- Atmosphere building
- Multiple connection modes
- Energy saving

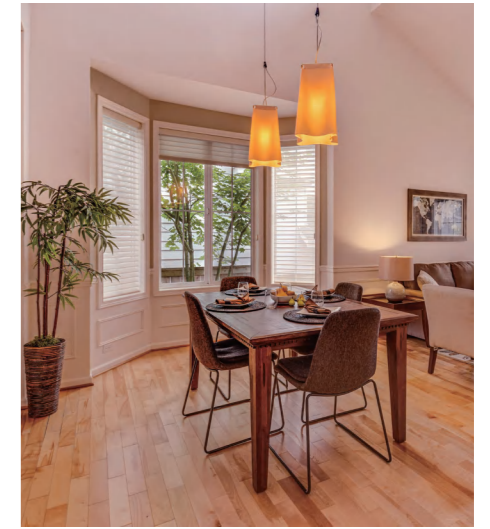
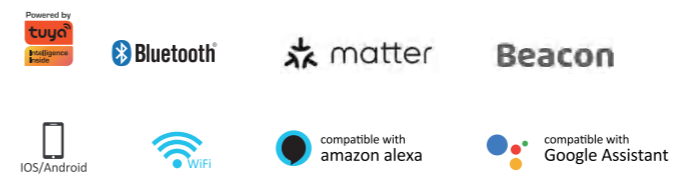

GU10



A19



BR30

Smart filament bulbs: WIFI+BLE, UL+T20, CRI90, CCT DIM

Item No.	Voltage(V)	watt(w)	Function	Lumen(lm)	CRI	PF	Beam Angle	Base	Life(hrs)
Glass GU10	120V	5.5W	CCT DIM (2200-6500K)	400LM	90	0.7	38°	GU10	15000
A19	120V	9.5W	CCT DIM (2200-6500K)	800LM	90	0.7	200°	E26	15000
BR30	120V	9.5W	CCT DIM (2200-6500K)	700LM	90	0.7	100°	E26	15000

SMART FILAMENT

Features:

- Easy to install
- Atmosphere building
- Multiple connection modes
- Energy saving

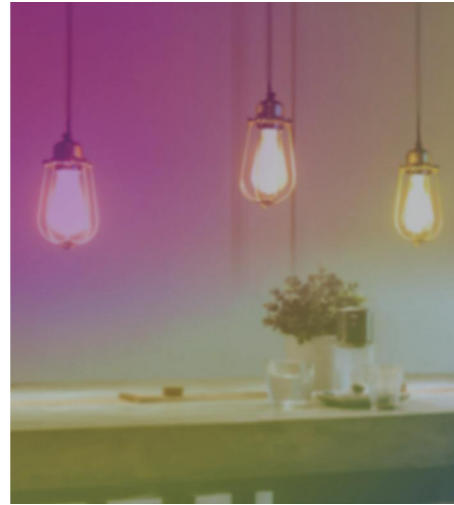
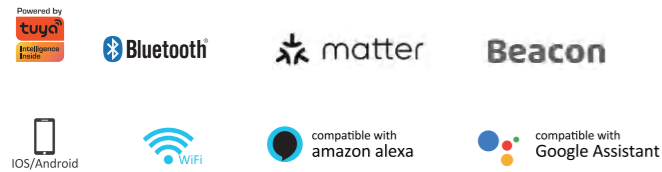

A19



ST19



B11



G25

Smart filament bulbs: WIFI+BLE, UL+T20, CRI90, CCT DIM

Item No.	Voltage(V)	watt(w)	Function	Lumen(lm)	CRI	PF	Beam Angle	Base	Life(hrs)
TUYA WIFI +BLE A19 ,CLEAR	120V	7.5W	CCT DIM (2200-6500K)	800LM	90	0.7	300°	E26	15000
TUYA WIFI+BLE ST19 , CLEAR	120V	7.5W	CCT DIM (2200-6500K)	800LM	90	0.7	300°	E26	15000
TUYA WIFI+BLE B11, CLEAR	120V	4W	CCT DIM (2200-6500K)	800LM	90	0.7	300°	E26	15000
TUYA WIFI+BLE G25 , CLEAR	120V	4W	CCT DIM (2200-6500K)	800LM	90	0.7	300°	E26	15000

US SMART WIFI PLUG

SMART WIFI PLUG 10A

1. Max. load current: 10A 1250W, 15A 1875W
2. Input AC125V 60Hz
3. Time Schedule Function
4. ETL FCC
5. WIFI Frequency: 2.4G



US SMART WIFI PLUG 15A

1. Max. load current: 15A 1875W
2. Input AC125V 60Hz
3. Time Schedule Function
4. ETL FCC
5. WIFI Frequency: 2.4G



SMART RETROFIT

Features:

- 1.RGB 16 Million Colors and Tunable White
- 2.Flexible Spring Design And Group Control
- 3.Sync with Music
- 4.Timer And Dimming
- 5.APP Intelligent Bluetooth Control

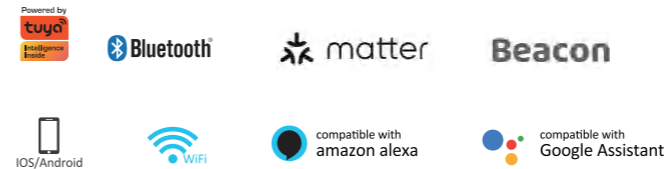

Item No.	Descriptions	PF	CRI	Eqv (W)	Dimension	certificate	certificate
4" RETROFIT DOWNLIGHT UL + FCC ES	4" 120V 8.7W 700LM TW 2700-5000K E26	0.9	80	65W	4"	UL+ES	EL+ES+T20+T24
4" RETROFIT DOWNLIGHT UL + FCC ES	4" 120V 8.7W 700LM RGB+ TW 2700-5000K E26	0.9	80	65W	4"	UL+ES	EL+ES+T20+T24
6" RETROFIT DOWNLIGHT UL + FCC ES	6" 120V 12W 850LM TW 2700-5000K ES slim backlit	0.9	80	65W	6"	UL+ES	EL+ES+T20+T24
6" RETROFIT DOWNLIGHT UL + FCC ES	6" 120V 12W 850LM RGB+TW 2700-5000K ES slim backlit	0.9	80	65W	6"	UL+ES	EL+ES+T20+T24

SMART REMOTE DOWNLIGHT

- 1.RGB 16 Million Colors and Tunable White
- 2.Flexible Spring Design And Group Control
- 3.Sync with Music
- 4.Timer And Dimming
- 5.APP Intelligent Bluetooth Control



Item No.	Descriptions	PF	CRI	Eqv (W)	Dimension	certificate	certificate
4" remote downlight UL + FCC ES	4" 120V 10W 650LM TW 2700-5000K ES slim backlit	0.9	80	65W	4"	UL+ES	EL+ES+T20+T24
4" remote downlight UL + FCC ES	4" 120V 10W 650LM RGB+TW 2700-5000K ES slim backlit	0.9	80	65W	4"	UL+ES	EL+ES+T20+T24
6" remote downlight UL + FCC ES	6" 120V 12W 850LM TW 2700-5000K ES slim backlit	0.9	80	85W	6"	UL+ES	EL+ES+T20+T24
6" remote downlight UL + FCC ES	6" 120V 12W 850LM RGB+TW 2700-5000K ES slim backlit	0.9	80	85W	6"	UL+ES	EL+ES+T20+T24

